

Les industries
Jessar
industries inc.

CATALOGUE LUMINAIRE
LIGHTING CATALOG

2022





TABLE DES MATIÈRES / TABLE OF CONTENTS



SPUTNIK
Page 4 - 7



**LUMINAIRES SUSPENDUS
PENDANT LIGHTS**
Page 8 - 15



**PENDANT LINÉAIRE
KITCHEN ISLAND**
Page 16 - 19



**LANTERN GÉOMÉTRIQUE
GEOMETRIC**
Page 20 - 21



DOME
Page 22 - 31



CAGE
Page 32 - 37



**RAIL D'ÉCLAIRAGE
TRACK LIGHTS**
Page 38 - 47



**PLAFONNIER
CEILING LIGHTS**
Page 48 - 51



**LUMIÈRES DE VANITÉ
VANITY LIGHTS**
Page 52 - 55



**LAMPE DE TABLE ET PIEDS
DESK & FLOOR LAMPS**
Page 56 - 61



**LUMINAIRE EXTÉRIEUR
OUTDOOR LIGHTS**
Page 62 - 75

SPUTNIK



SPUTNIK

5-90114 FREEDOM



5-90010 LUCERNE

Hauteur ajustable - comprend 5 tiges
Adjustable height - includes 5 stems



5-90128 JENSEN



SPUTNIK



SPUTNIK

5-90234 ELIXIR



5-90235 ELIXIR

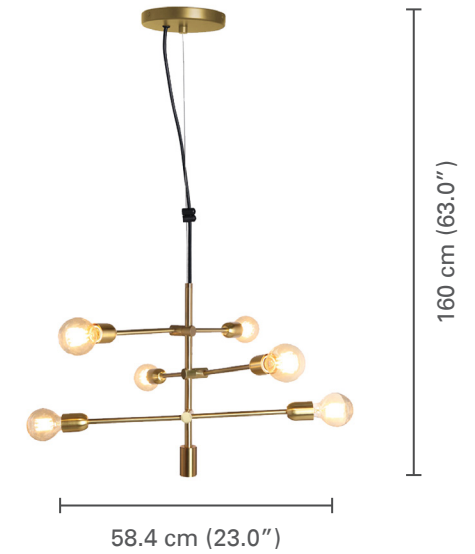

5-90211 SKYLIGHT
Hauteur ajustable - comprend 3 tiges
Adjustable height - includes 3 stems

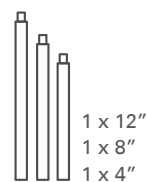

5-90212 ROCKLAND

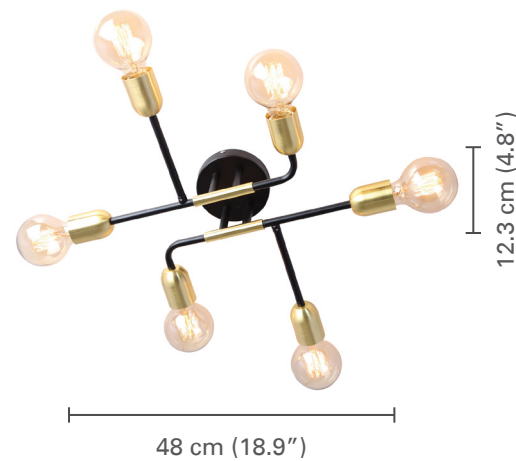

LUMINAIRES SUSPENDUS / PENDANT LIGHTS



LUMINAIRES SUSPENDUS / PENDANT LIGHTS

5-90180 BROADWAY



5-90113 GRIMALDI



5-90130 MABEL



5-90131 ELLINGSON



LUMINAIRES SUSPENDUS / PENDANT LIGHTS

5-90136 VIRGINIA



5-90144 CONNEXION



5-90122 STANFORD



5-90182 FLORENCE



5-90197 GUSTAVO

Hauteur ajustable - comprend 5 tiges
Adjustable height - includes 5 stems



5-90155 MURPHY



5-90187 OPERA



LUMINAIRES SUSPENDUS / PENDANT LIGHTS

5-90196 BOLIVIA

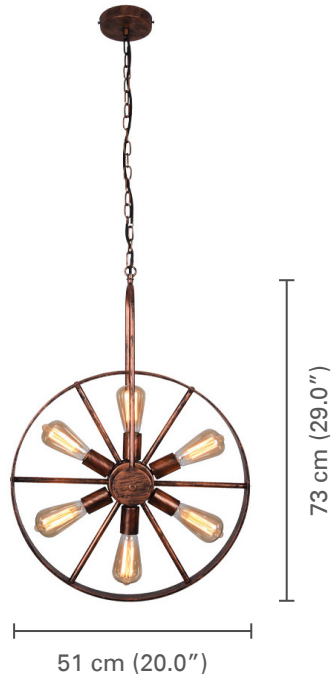

5-90115 GIULIO

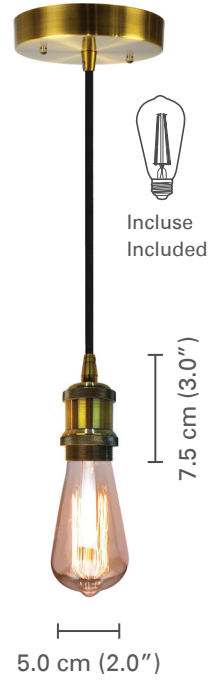

5-90116 GIULIA

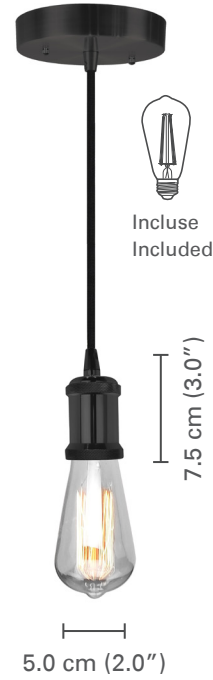

5-90094 WEBBER



5-90117 HENRY

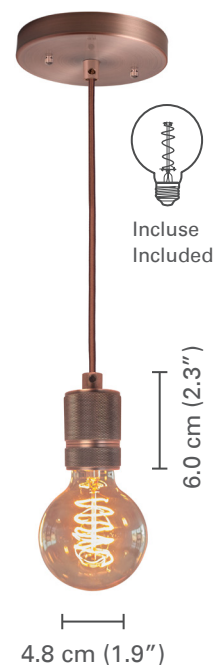

LUMINAIRES SUSPENDUS / PENDANT LIGHTS

5-90194 BOHANNON

Hauteur ajustable - comprend 5 tiges
Adjustable height - includes 5 stems

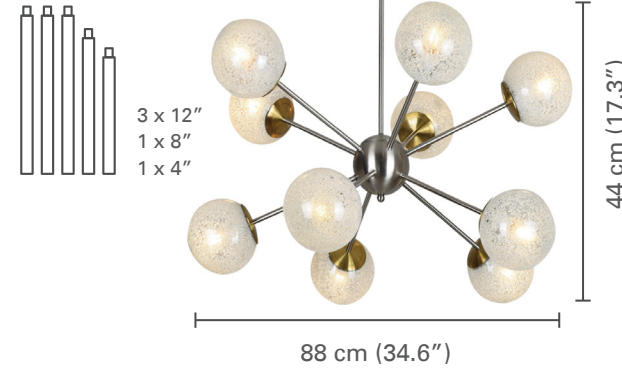

5-90198 HENDERSON

Hauteur ajustable - comprend 5 tiges
Adjustable height - includes 5 stems



5-90207 BOHANNON

Hauteur ajustable - comprend 5 tiges
Adjustable height - includes 5 stems

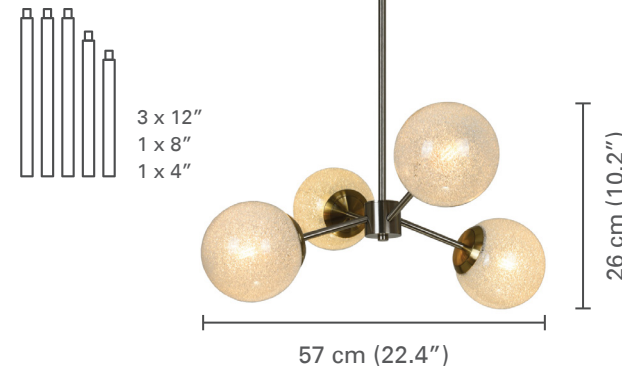

5-90208 HENDERSON

Hauteur ajustable - comprend 5 tiges
Adjustable height - includes 5 stems



5-90209 BOHANNON



5-90210 HENDERSON



LUMINAIRES SUSPENDUS / PENDANT LIGHTS

5-90255 REPLY



5-90256 REPLY



LUMINAIRES SUSPENDUS - LUSTRE / PENDANT LIGHTS - CHANDELIER

5-90233 ANDALUSIAN

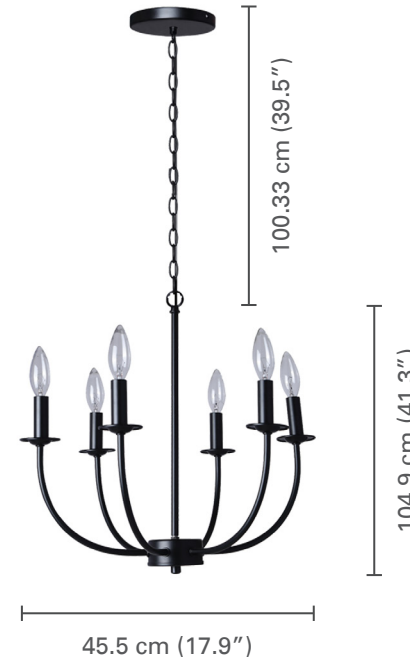

5-90251 WESTGATE

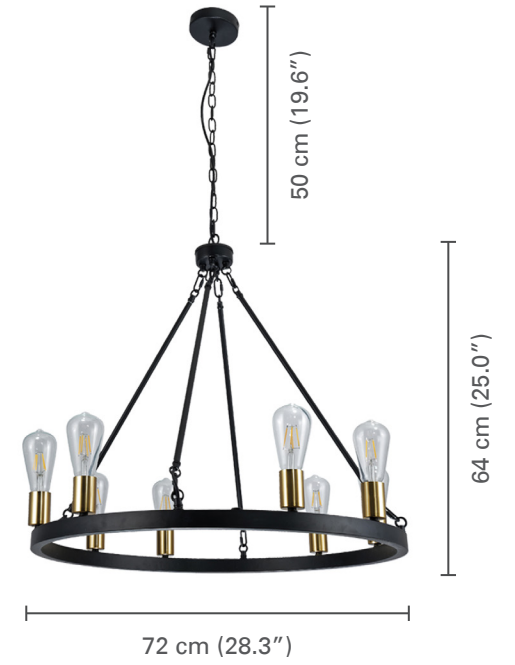

5-90257 REPLY



5-90258 REPLY



5-90248 TOSCANA



5-90249 TOSCANA

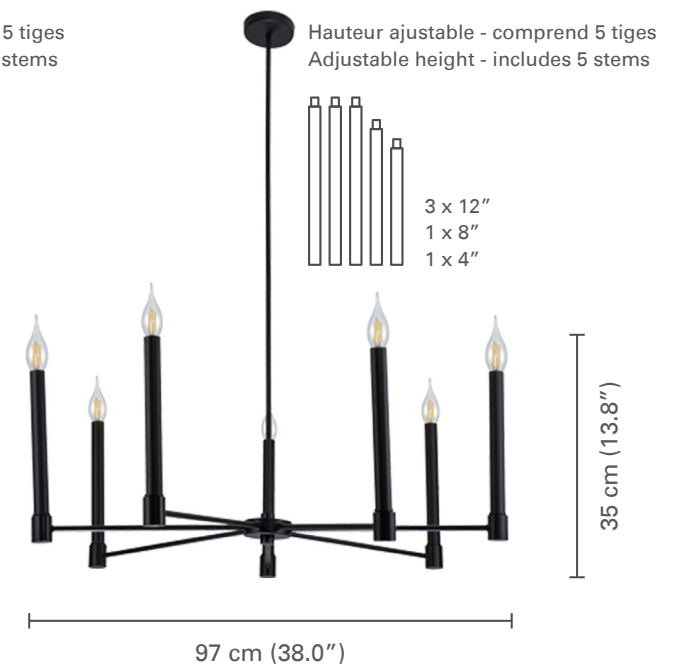

PENDANT LINÉAIRE / KITCHEN ISLAND



PENDANT LINÉAIRE / KITCHEN ISLAND

5-90012 HARRISON

Hauteur ajustable - comprend 5 tiges
Adjustable height - includes 5 stems



5-90126 DAKOTA



5-90129 GLORIA

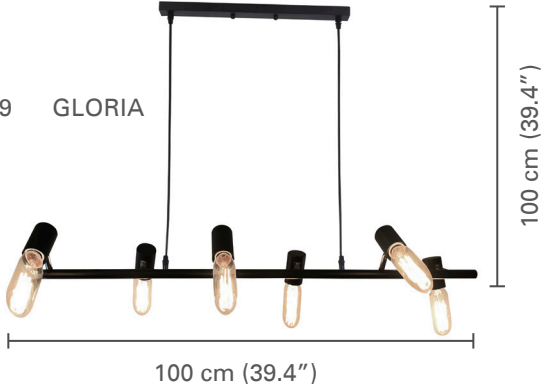

5-90134 PALMER



5-90195 ARISTOCRAT

Hauteur ajustable - comprend 5 tiges
Adjustable height - includes 5 stems

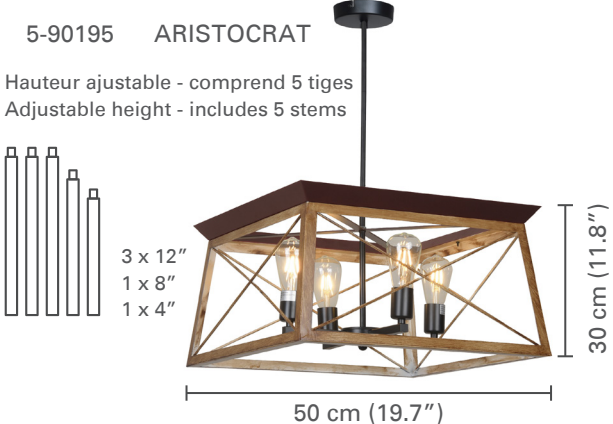

PENDANT LINÉAIRE / KITCHEN ISLAND

5-90151 LOUVRE



5-90158 NELSON



PENDANT LINÉAIRE / KITCHEN ISLAND

5-90179 CASINO



5-90183 KIMBERLY



5-90164 NOBLE



5-90165 OXFORD



5-90003 BOLTON

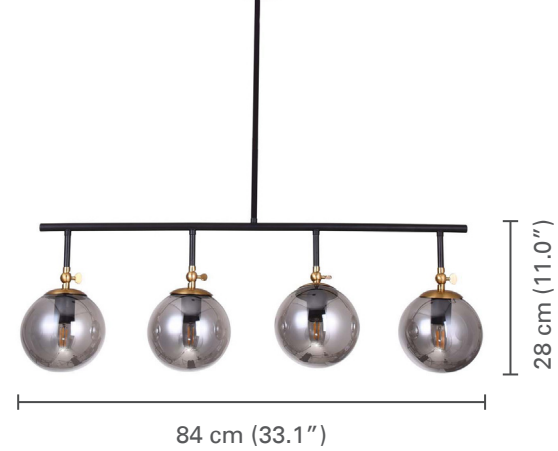

5-90011 FRANKLIN

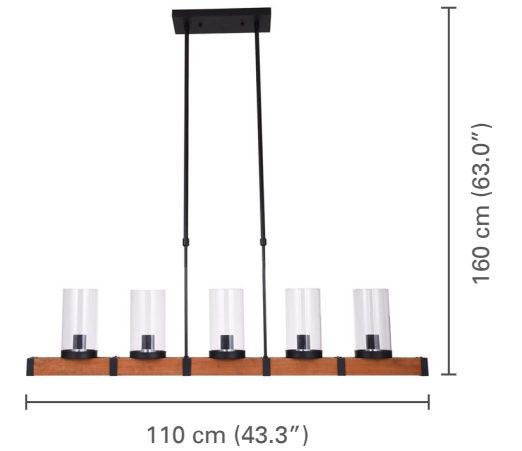

5-90013 NEW YORK



5-90006 NORWAY



5-90123 CHARLES



4-80403 MAJESTIC

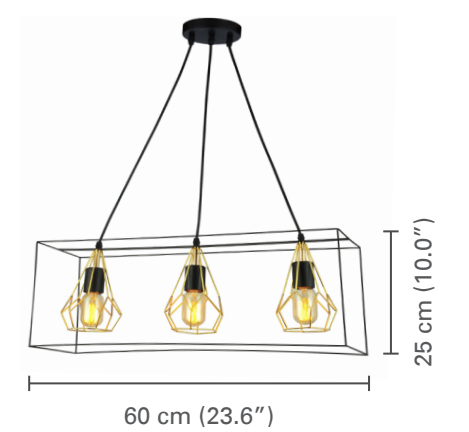

LANTERN GÉOMÉTRIQUE / GEOMETRIC



LANTERN GÉOMÉTRIQUE / GEOMETRIC

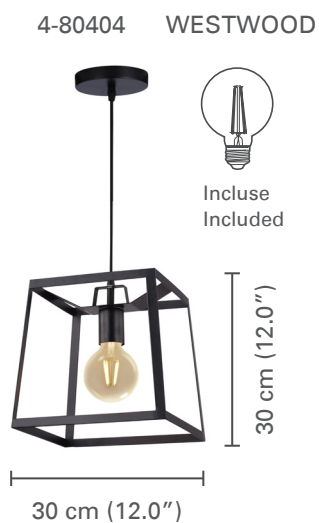

DOME



DOME

5-90124 GORDON



5-90186 MERIDIAN



5-90146 GRANT



5-90147 GRANT



5-90148 BRENTFORD



5-90149 BROOKLYN



DOME

5-90150 COPENHAGEN



5-90152 FOSTER



5-90153 BLACK MOON



5-90156 MOLLY



5-90159 MILA



DOME

5-90160 MELROSE



5-90161 ODESSA



5-90168 PORTLAND



5-90169 PORTLAND



5-90170 PORTLAND



DOME

5-90171 NORWOOD



5-90098 ASHFORD



5-90175 ALPHA



DOME

5-90096 BEVERLY



5-90101 CHRISTY



5-90097 BEVERLY

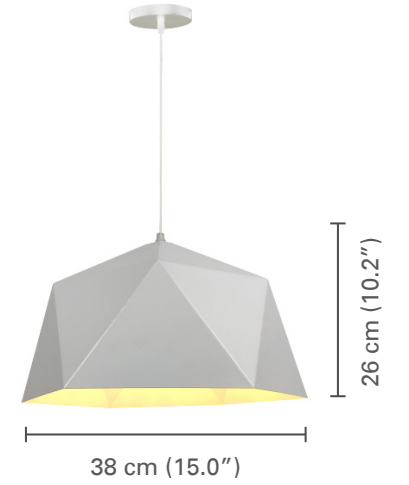

5-90100 CHRISTY



DOME

5-90102 CENTRAL STATION



5-90103 CENTRAL STATION

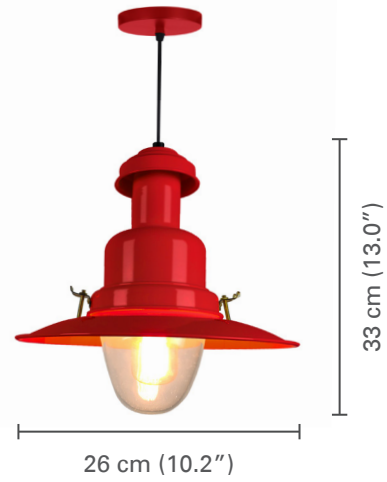

5-90105 DECLAN



5-90106 DECLAN



DOME

5-90099 BOLERO



5-90118 JAZZI



5-90000 BELMONT



5-90001 BELMONT



DOME



DOME

5-90176 CAVALIOFF



5-90008 KOKKINO



5-90004 BIXHAM



5-90002 CELESTE



5-90226 ELVA



4-80401 AMBER GLASS



4-80402 CLEAR GLASS



5-90227 ELVA



CAGE



CAGE

5-90135 VOLCANO



5-90137 VIRGINIA



5-90142 CARLTON



5-90143 CARLTON



5-90145 FLOYD



5-90162 MONACO



CAGE

5-90163 MONTE CARLO



5-90181 CLEVELAND



CAGE

5-90107 EUGENE

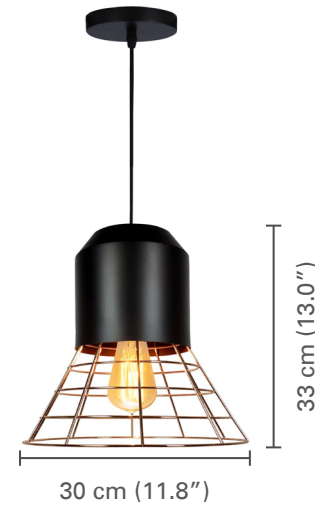

5-90108 DUTCH



5-90178 DEVON



5-90104 EDEN



5-90112 HOUSTON



5-90110 ELTON



CAGE



5-90269 BALDWIN



CAGE

5-90252 QUEENSDOWN



5-90253 QUEENSDOWN



5-90250 VERONICA

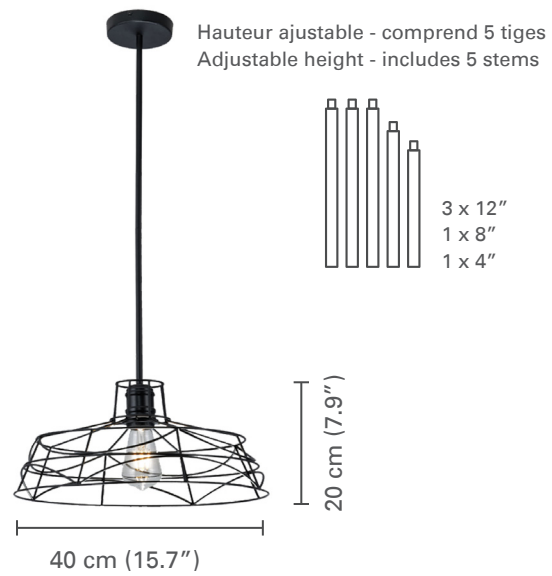

5-90254 SHADOW



RAIL D'ÉCLAIRAGE / TRACK LIGHTS



RAIL D'ÉCLAIRAGE / TRACK LIGHTS

5-90067 WESTMINSTER



5-90068 WESTMINSTER

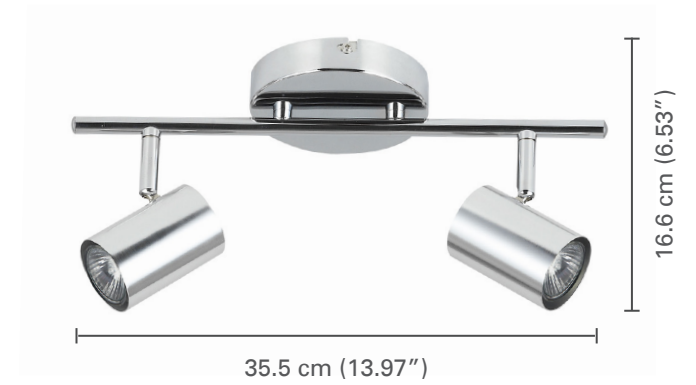

5-90069 WESTMINSTER



5-90070 WESTMINSTER





RAIL D'ÉCLAIRAGE / TRACK LIGHTS

5-90033 YORKSHIRE



5-90034 YORKSHIRE



5-90035 YORKSHIRE



5-90036 YORKSHIRE



5-90037 YORKSHIRE





RAIL D'ÉCLAIRAGE / TRACK LIGHTS

5-90073 RIVIERA

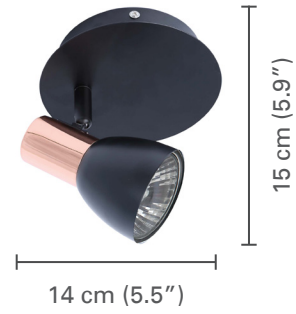

5-90074 RIVIERA



5-90075 RIVIERA



5-90071 WALTER



5-90072 WALTER



5-90076 RIVIERA





RAIL D'ÉCLAIRAGE / TRACK LIGHTS

5-90081 ANITA



5-90082 ANITA



5-90077 OSCAR



5-90078 OSCAR



5-90083 ANITA



5-90080 OSCAR



5-90084 ANITA





5-90085 HOPE

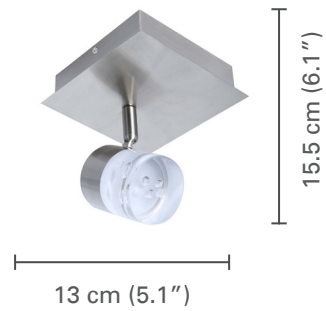

5-90086 HOPE



5-90088 HOPE

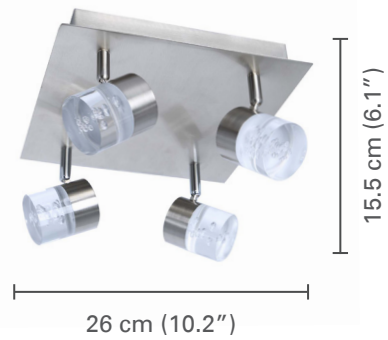

5-90087 HOPE



RAIL D'ÉCLAIRAGE / TRACK LIGHTS

5-90223 JACKSON



5-90224 JACKSON



5-90225 JACKSON

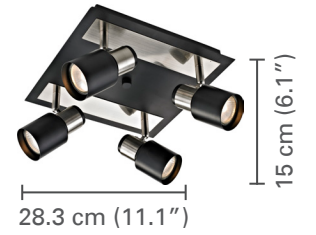

5-90228 HARBOUR

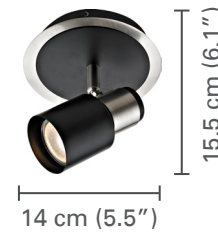

5-90229 HARBOUR



5-90230 HARBOUR



PLAFONNIER / CEILING LIGHTS



PLAFONNIER / CEILING LIGHTS

1-69931 CARREY 11"



1-69932 CARREY 14"



1-69933 CORINA 11"



1-69934 CORINA 14"



1-69919 VERONA 11" 4000K



1-69920 VERONA 11" 4000K



1-69939 VERONA 11" 3000K



1-69940 VERONA 11" 3000K



PLAFONNIER / CEILING LIGHTS

1-69924 VERONA 13" 3000K



1-69941 ROSS 11" 3000K



1-69921 MILANO 12" 4000K



1-69922 MILANO 12" 4000K



PLAFONNIER / CEILING LIGHTS



5-90199 DUBLIN



30 cm (11.8")

8 cm (3.1")

5-90244 SWEDEN



35 cm (13.8")

17.5 cm (6.9")

5-90245 PANAMA



30 cm (11.8")

15 cm (5.9")

5-90246 SUNKEY



42 cm (16.5")

27 cm (10.6")

5-90247 PRESTON



30 cm (11.8")

24 cm (9.4")

LUMIÈRES DE VANITÉ / VANITY LIGHTS



LUMIÈRES DE VANITÉ / VANITY LIGHTS

5-90200 ROCKVIEW
(DEL / LED)

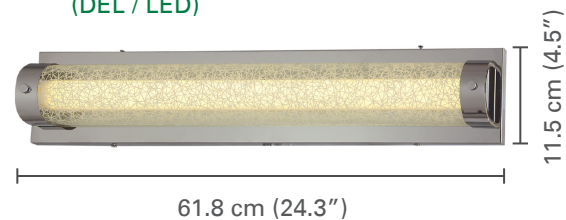

5-90201 ROCKVIEW
(DEL / LED)



5-90202 FAIRVIEW

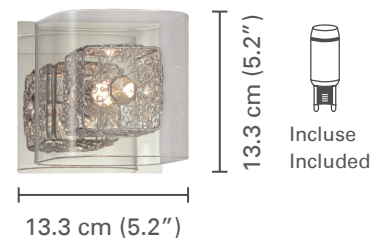

5-90203 FAIRVIEW



5-90204 FAIRVIEW

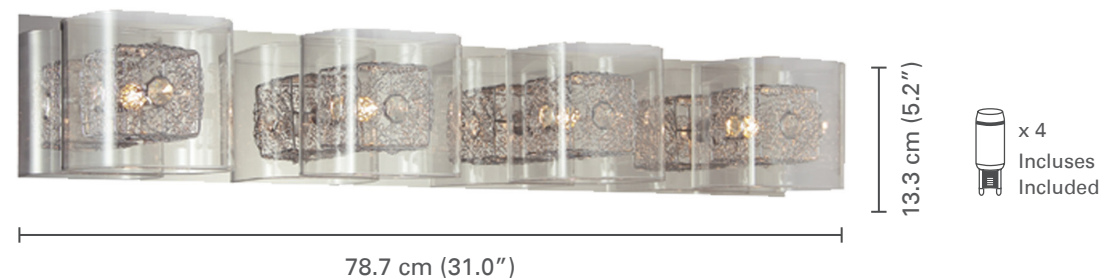

5-90205 CHRISTALINA
(DEL / LED)



5-90206 CHRISTALINA
(DEL / LED)





LUMIÈRES DE VANITÉ / VANITY LIGHTS

5-90217 DAWSON



5-90218 DAWSON

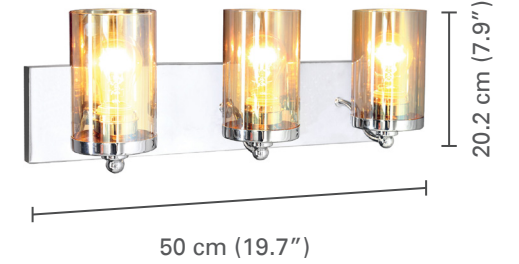

5-90219 DAWSON

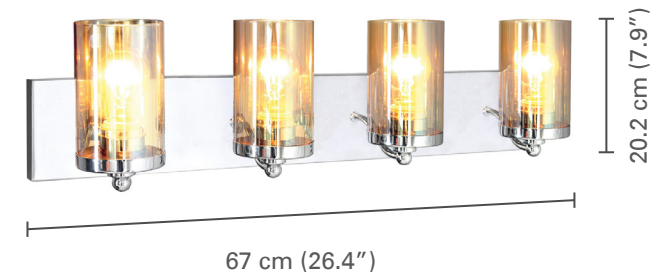

5-90213 BALTIMORE

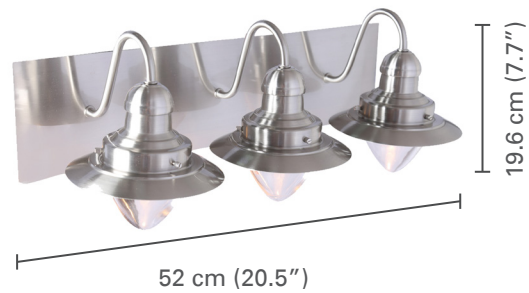

5-90214 BALTIMORE

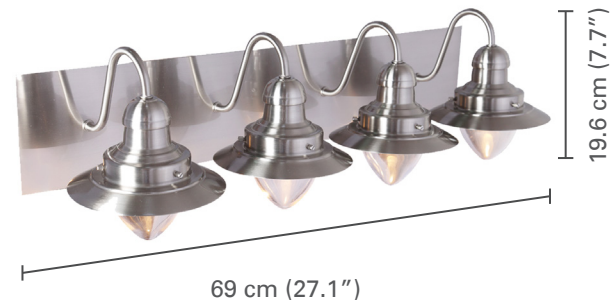

5-90215 RIVA

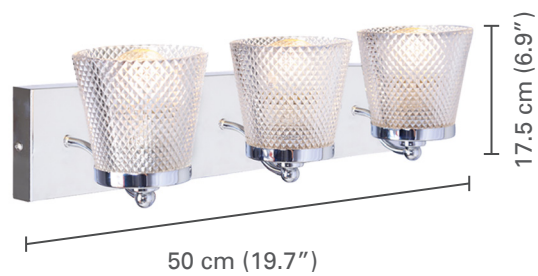

5-90216 RIVA

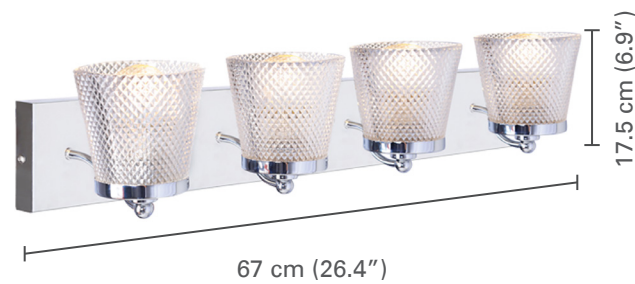

LAMPE DE TABLE ET PIEDS / DESK & FLOOR LAMP



LAMPE DE TABLE ET PIEDS / DESK & FLOOR LAMP

5-90138 VIRGINIA



5-90231 CAPE TOWN

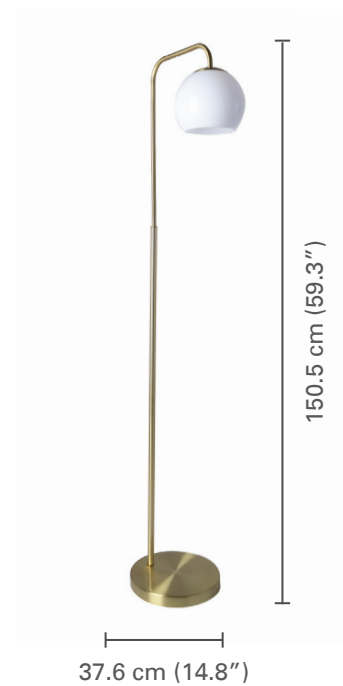

5-90025 SYDNEY

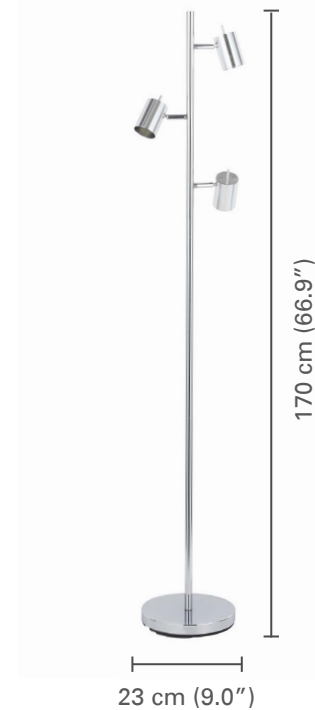

5-90232 CAPE TOWN

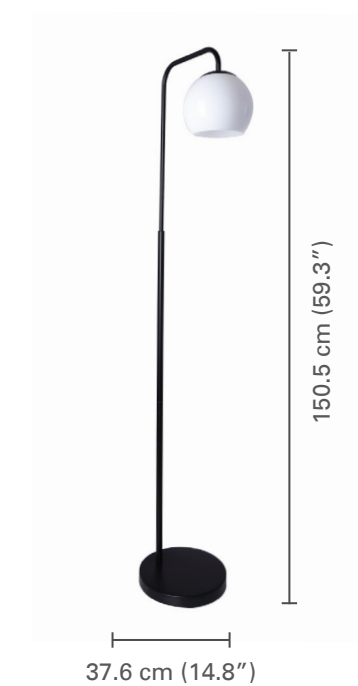

5-90140 PARKER

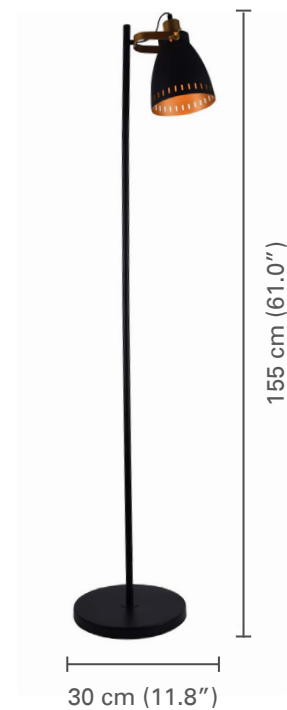

LAMPE DE TABLE ET PIEDS / DESK & FLOOR LAMP

5-90092 ANDERSON



5-90029 NIRVANA



LAMPE DE TABLE ET PIEDS / DESK & FLOOR LAMP

1-69070 COLEMAN



1-69069 CLASSIC



1-69071 CONROY



1-69072 FELIX



1-69057 DELANO



1-69058 ADRIEN



5-90139 PARKER



5-90121 LOFOTEN



LAMPE DE TABLE ET PIEDS / DESK & FLOOR LAMP

1-69059 AUTENTICA



1-69060 TRAVIS



1-69064 TAYLOR

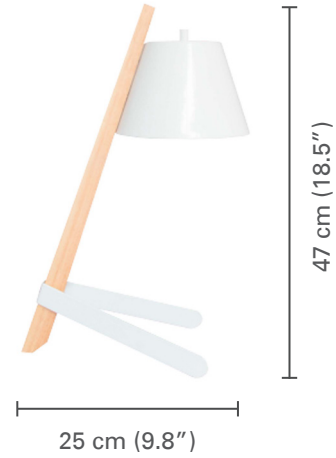

5-90024 STUDIO



1-69062 SPENCER



1-69067 TODD



1-69066 SHILO



1-69065 WOODWARD



1-69055 RETRO



1-69056 RETRO



5-90141 BRADLEY



5-90120 LUNA



LUMINAIRES EXTÉRIEURS / OUTDOOR LIGHTS



LUMINAIRES EXTÉRIEURS / OUTDOOR LIGHTS

5-90040 BOURNE



5-90055 MARVIN



5-90042 BAILEY



5-90043 BELZ



5-90044 EDGAR



5-90045 CAMILA



LUMINAIRES EXTÉRIEURS / OUTDOOR LIGHTS

5-90046 BROOKE



5-90047 COOPER



5-90050 DUCAN



5-90051 DUKE



5-90048 CUMBRIA



5-90049 CASSIDY



5-90052 GARRY



5-90056 FERGUSON



LUMINAIRES EXTÉRIEURS / OUTDOOR LIGHTS

5-90053 GRAHAM



5-90054 GRAHAM



LUMINAIRES EXTÉRIEURS / OUTDOOR LIGHTS

5-90014 PRESCOTT



5-90063 LONDON



5-90057 JADA



5-90089 OLD TOWN



LUMINAIRES EXTÉRIEURS / OUTDOOR LIGHTS

5-90015 PORTER



5-90091 PORTER



LUMINAIRES EXTÉRIEURS / OUTDOOR LIGHTS

5-90019 CANDICE



5-90020 AUGUST



5-90017 AMSTERDAM



5-90018 BELLA



5-90021 WINSLOW

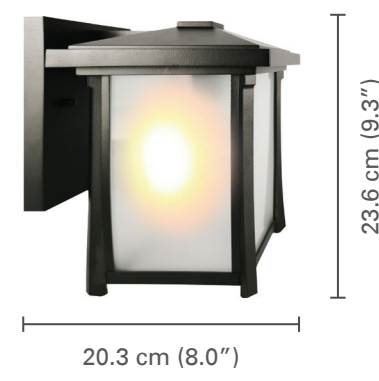

5-90022 VIRGINIA



5-90023 DUVAL



5-90016 RENOLDS



LUMINAIRES EXTÉRIEURS / OUTDOOR LIGHTS



5-90267 AUBREY

5-90268 DORCHESTER



5-90264 ALANAH



LUMINAIRES EXTÉRIEURS / OUTDOOR LIGHTS

5-90265 MONTCALM



5-90266 BALI



LUMINAIRES EXTÉRIEURS / OUTDOOR LIGHTS



5-90190 CENTRAL PARK

5-90239 CENTRAL PARK



5-90191 CENTRAL PARK

LUMINAIRES EXTÉRIEURS / OUTDOOR LIGHTS

5-90259 KANSAS

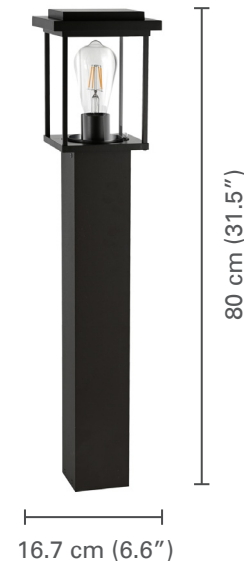

5-90260 MARSHALL

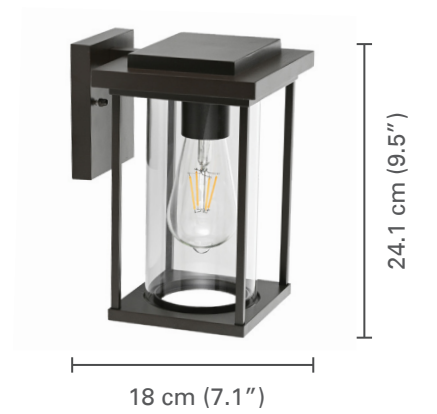

5-90192 BRIDGE



5-90193 BRIDGE



LUMINAIRES EXTÉRIEURS - DEL INTÉGRÉES / OUTDOOR LIGHTS - INTEGRATED LED

4-80081 JULIETTE 10" 3000K
(DEL / LED)



4-80083 ESTHER 13" 3000K
(DEL / LED)



4-80084 OLIVIA 10" 3000K
(DEL / LED)



5-90240 WILSON 12" 3000K
(DEL / LED)



5-90241 WILSON 18" 3000K
(DEL / LED)

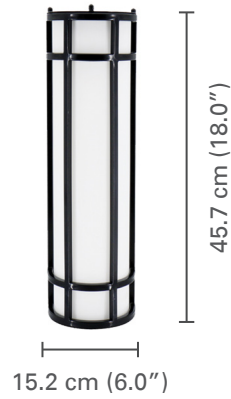

5-90242 VIVA 8" 3000K
(DEL / LED)

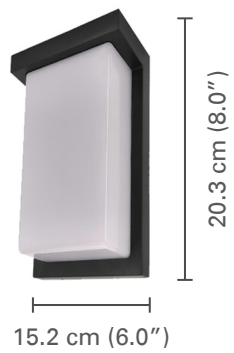

5-90243 VIVA 14" 3000K
(DEL / LED)



LUMINAIRES EXTÉRIEURS - DEL INTÉGRÉES / OUTDOOR LIGHTS - INTEGRATED LED



5-90261 MALIBU
(DEL / LED)

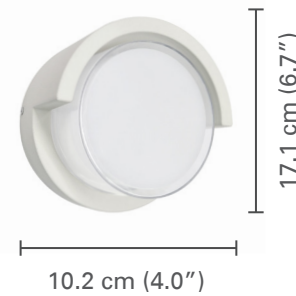

3 options de couleurs
3 color options
3000K / 4000K / 5000K

5-90262 MALIBU
(DEL / LED)

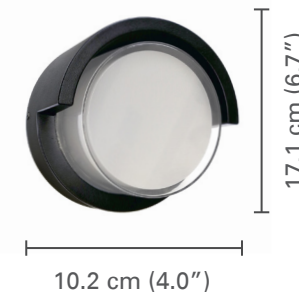

3 options de couleurs
3 color options
3000K / 4000K / 5000K

5-90263 MONTANA 3000K
(DEL / LED)

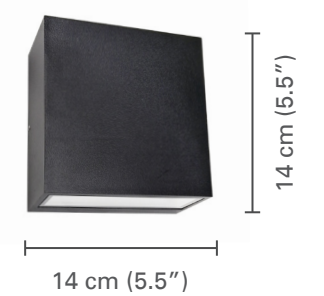



CATALOGUE LUMINAIRE
LIGHTING CATALOG
2022

Les industries
Jessar
industries inc.

341 Allée Du Golf
St-Eustache, Québec
Canada J7R 0L5

Tel : 450 472 0280
Fax: 450 472 1280

E-mail: info@jessar.ca
www.jessar.ca

April 2022